

StiFlex

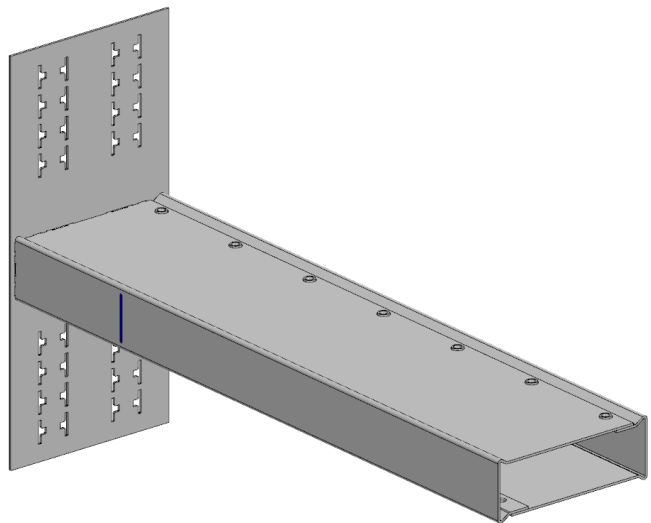

CLR1706/600
CLR1706/600-W

HLB

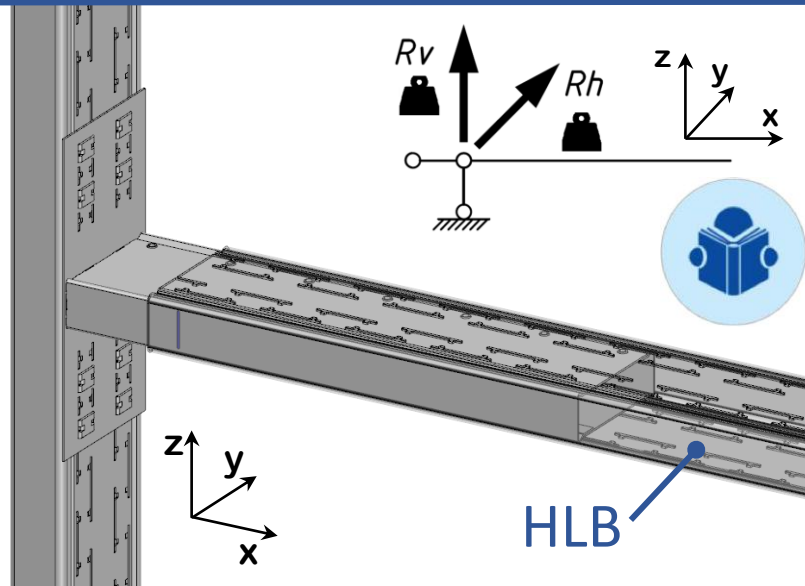

HLB

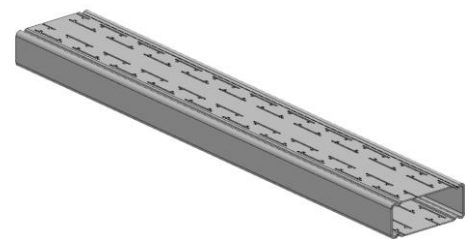
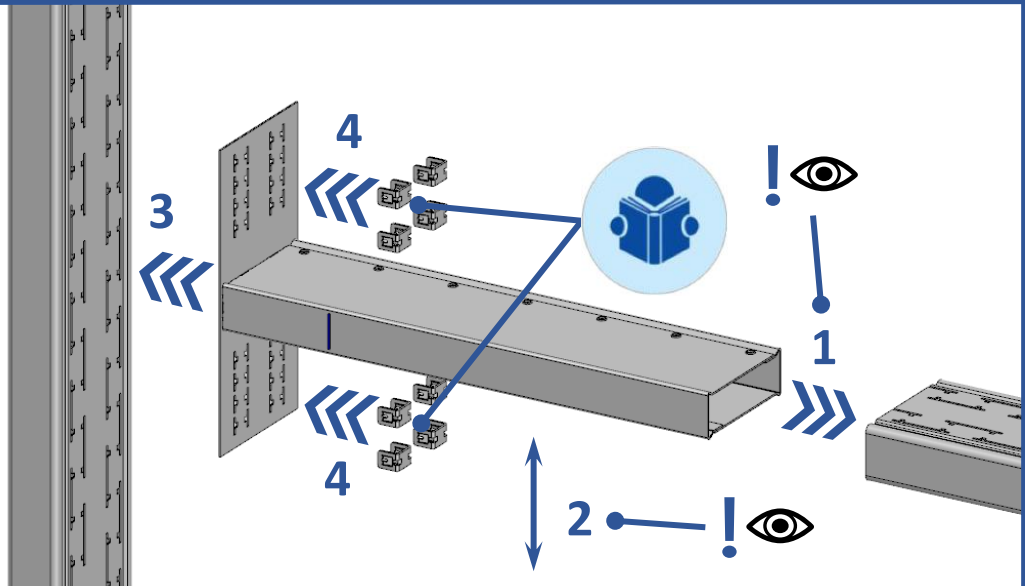

1x MR170620

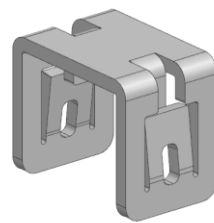

8x FLR

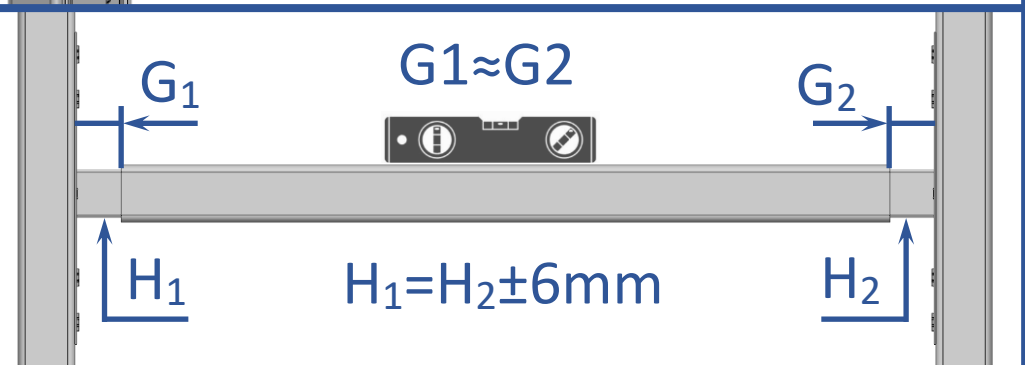

$G_1 \approx G_2$

$H_1 = H_2 \pm 6\text{mm}$

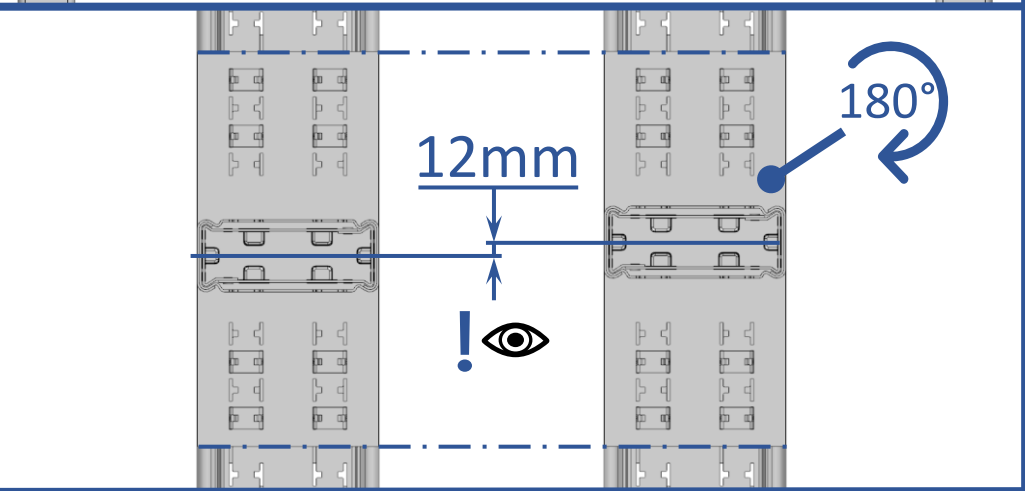
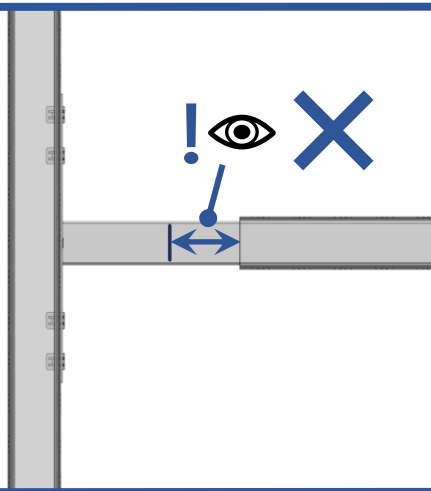
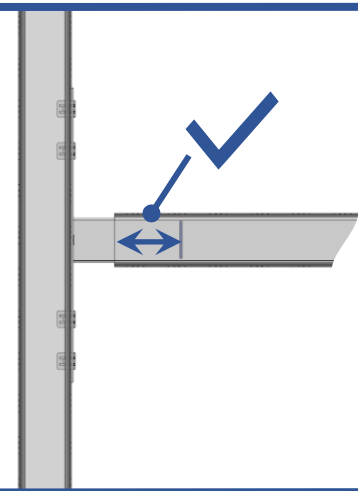

12mm

180°