

Stiflex

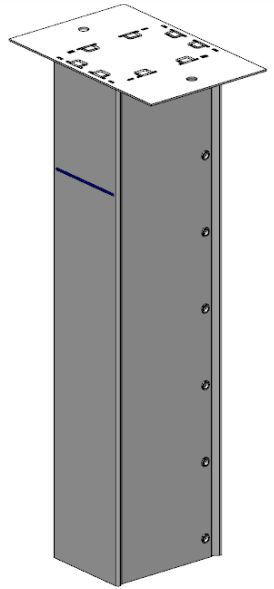

CF1713/600
CF1713/600-W

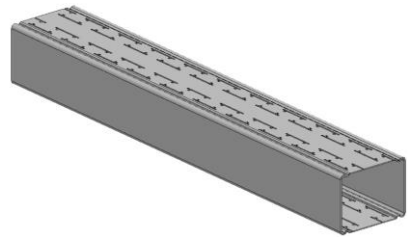
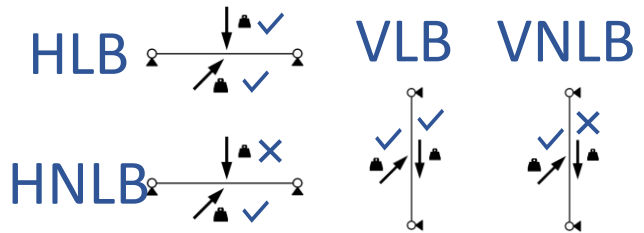
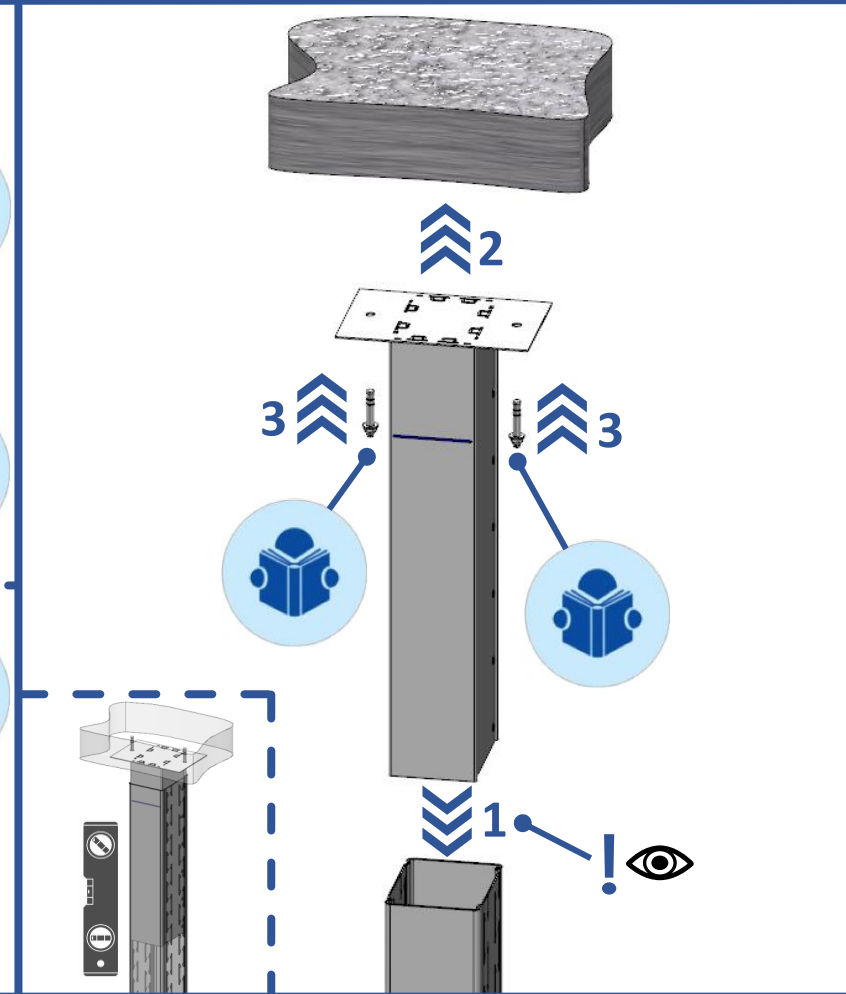
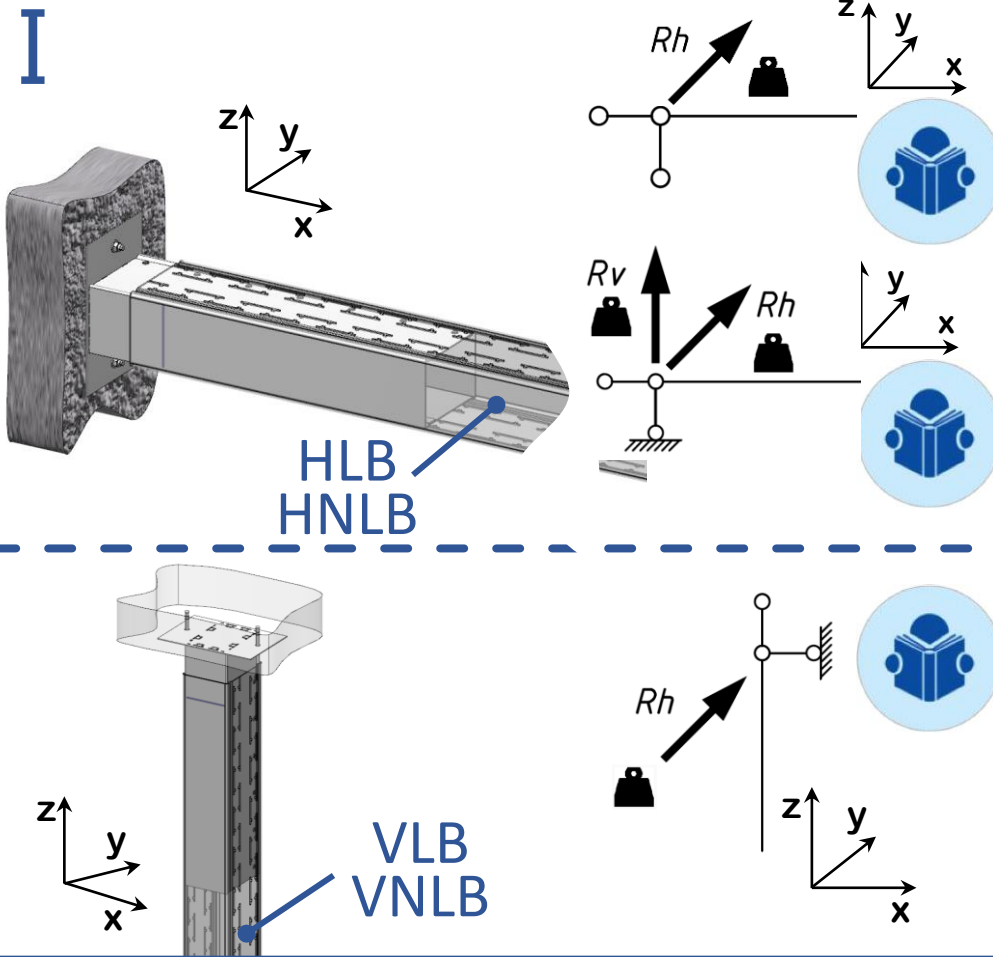

1x MR171320 /
1x MR171330

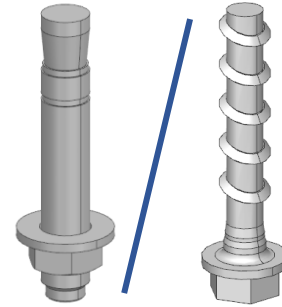

2x M10

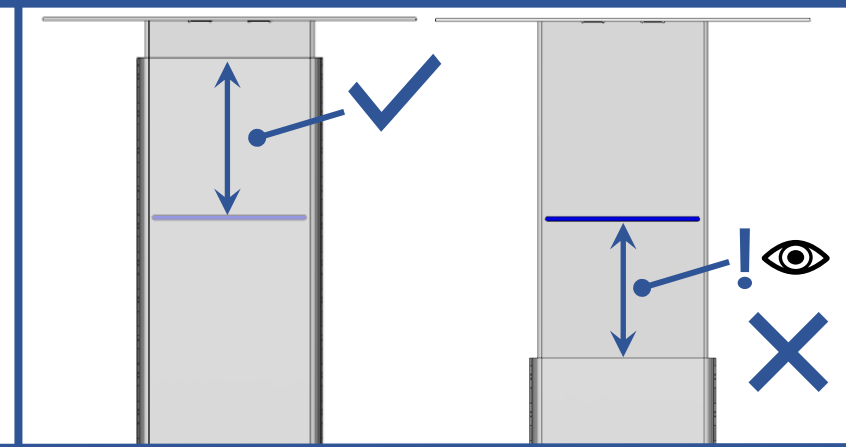

StiFlex

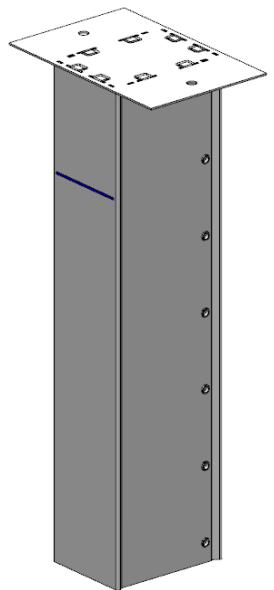

CF1713/600
CF1713/600-W

IIa

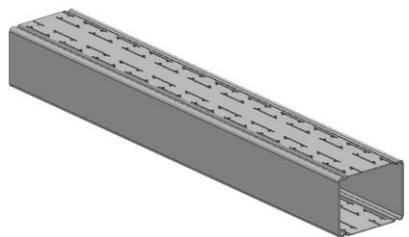
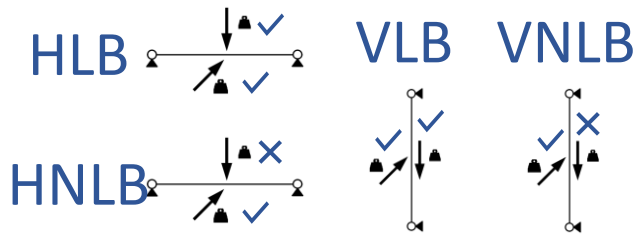
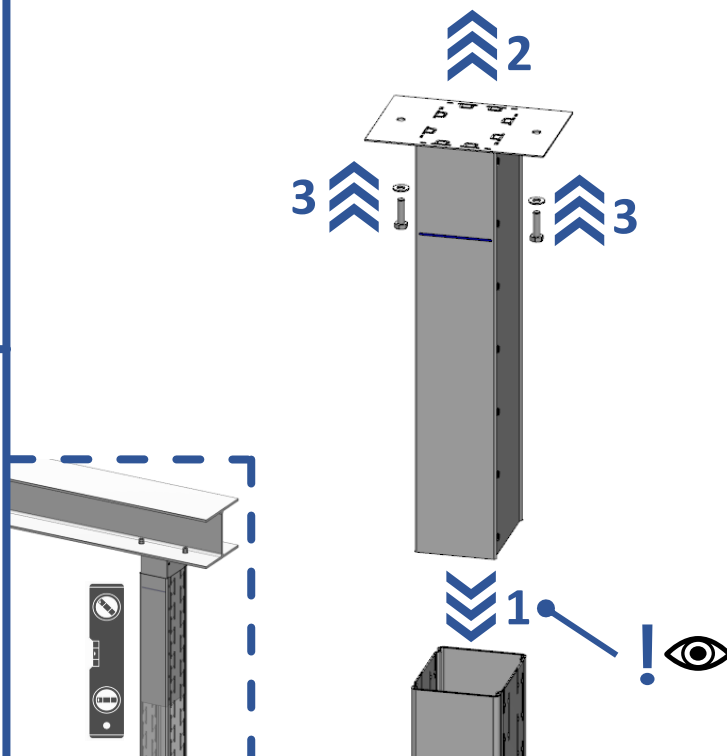
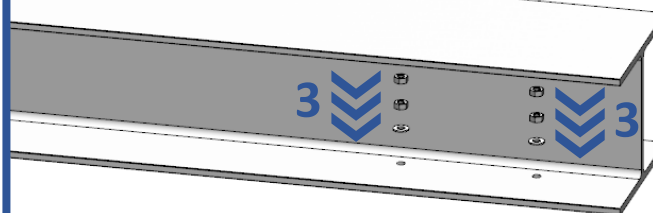
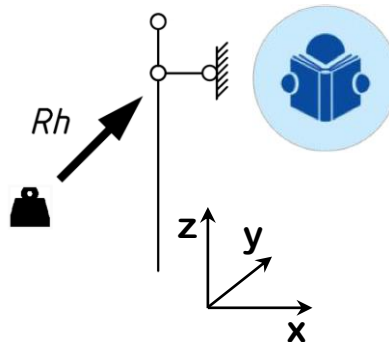
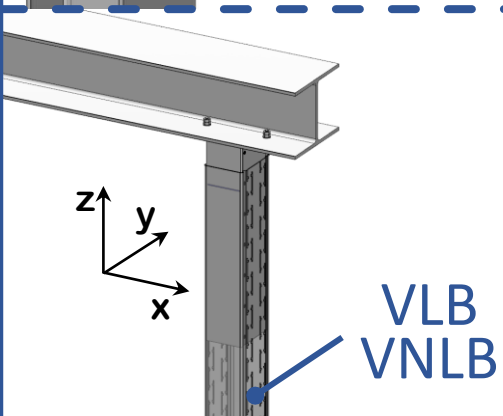
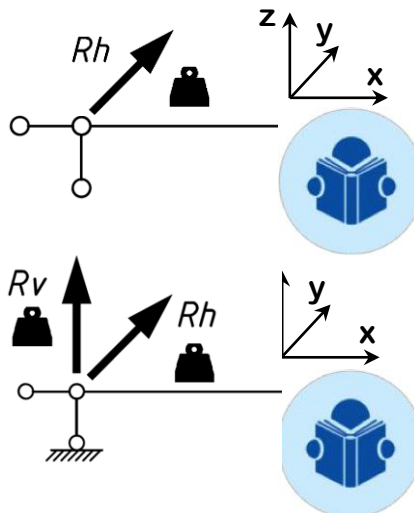
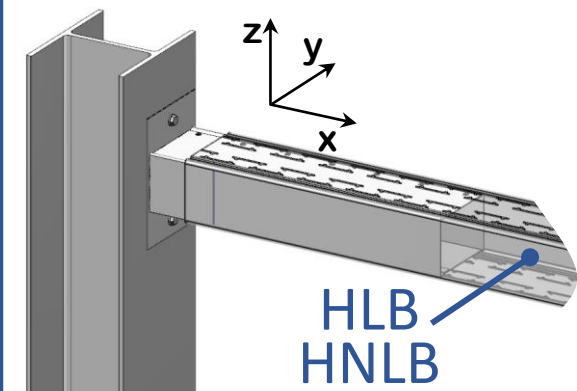

1x MR171320 /
1x MR171330

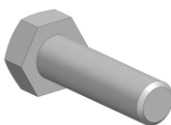

2x M10

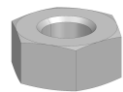

4x M10



4x M10

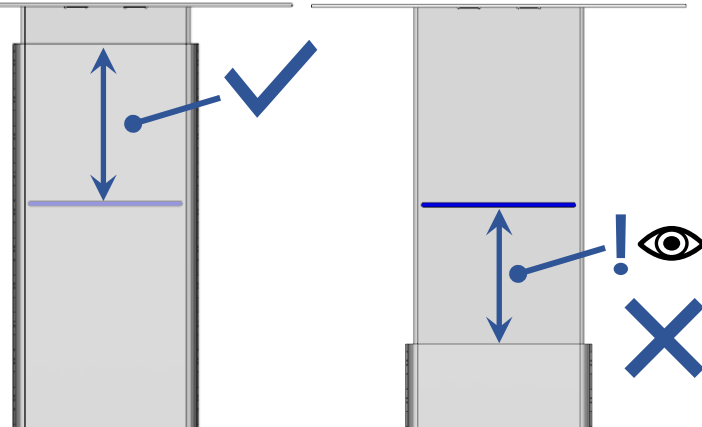

Stiflex

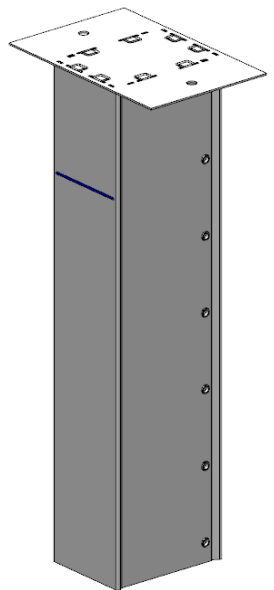

CF1713/600
CF1713/600-W

IIb

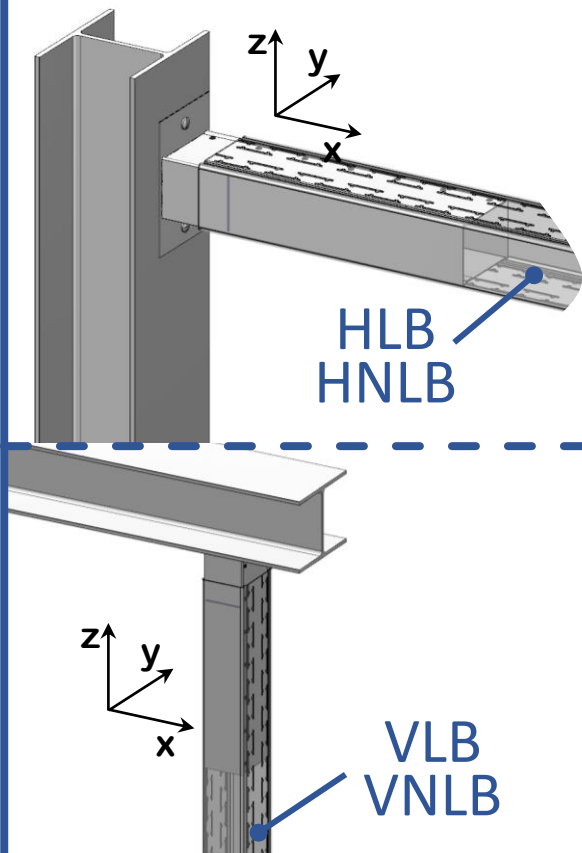

HLB
HNLB

VLB
VNLB

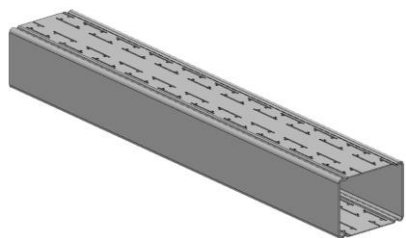
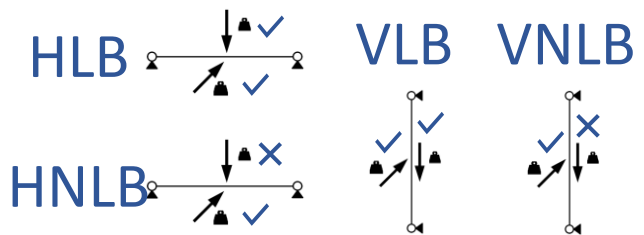
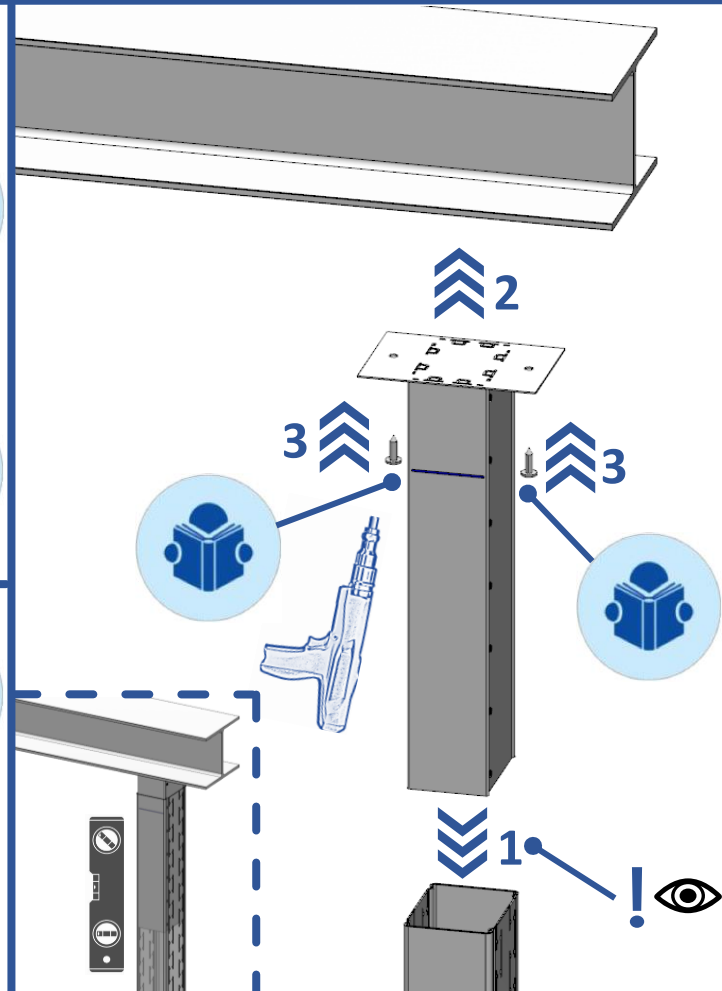
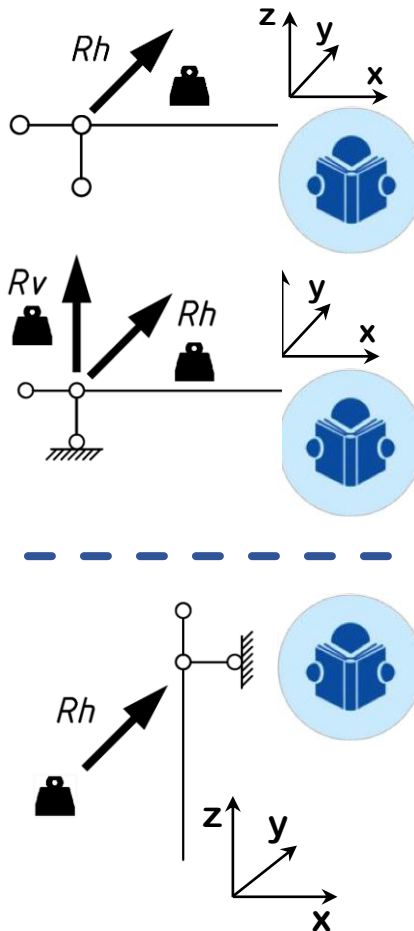

1x MR171320 /
1x MR171330



2x

